



厦门强力巨彩光电科技有限公司

Xiamen Qiangli Jucai Opto-Electronic Technology Co., Ltd.

Product Specification

Product: Indoor Full Color P3.0 1/26 Scan Module

Model: Q3.0-26S-Pro-2020

Item No.: _____

Version: 2.7

Drafting:	Review:	Approval: (Seal)

Address: No. 8065, Building E6, West Xiang'an Road, Xiang'an Torch High-Tech Industrial Zone, Xiamen, Fujian China

Service +62 812-3023-0921

E-mail: qiangli.indonesia@gmail.com

Website: www.qiangliled.com



1. Scope of application

This technical manual is only applicable to the indoor LED display **Q3.0-26S-Pro-2020** unit board, the following are conventional product parameters, and can be customized if you have special requirements.

2. Precautions

Item		Description
Environmental Precautions	Temperature requirement	Storage temperature range: $-10^{\circ}\text{C} - 30^{\circ}\text{C}$, over 30°C needs to do cooling treatment. Operating temperature range: $-20^{\circ}\text{C} - 40^{\circ}\text{C}$, other temperature range, need to install temperature control equipment. Lamp surface temperature (working time): $\leq 60^{\circ}\text{C}$, temperature control equipment is required to be installed when temperature exceeding the standard
	Humidity requirement	Storage humidity range: 10% RH-60% RH, humidity over 60% RH requires dehumidification treatment. Operating humidity range: 10% RH-65% RH, If the humidity exceeds the standard, it must be dehumidified before it can be used normally.
	Storage overdue processing	If the product has been stored for more than one month, need to do 6 hours of aging test before it can be used. The aging mode is: 10%Full brightness setting-1H, 30%Full brightness setting-1H, 60%Full brightness setting-2H, 80%Full brightness setting-1H, 100%Full brightness setting-1H (increase brightness gradually in aging test)
	Dust-proof requirements	Indoor products have no protection level or IP30, and the display should not be exposed to heavy dusty environments, such as decoration and renovation. Special protection is required to protect the display. Installing LED display screen during decoration is strictly prohibited.
	Avoiding corrosive gas	Corrosive gas contains salt or acid gas in the environment, may cause corrosion of electronic components, crystallization, leakage and so on.
	Avoiding electromagnetic radiation	The display screen should not be installed in an environment where electromagnetic radiation and radio frequency radiation exceed the field strength of 5V/m interference source.
	Avoid strong light	Strong light will affect the display effect and life span of screen. It should be install in the direction where there is shorter direct sun shining.
	Keep away from water	Indoor products have low level of protection, water can make the module short circuit, and leads to circuit device damage,



Environmental Precautions		so it is necessary to keep away from the water source.
	Electrostatic hazard, Prevent lightning strikes	The metal components of the screen, the shell of power supply and the cabinet should be grounded well, and the grounding resistance should be less than $10\ \Omega$. Prevent electrostatic damage to electronic devices in humid environment, while avoiding electric leakage to harm human body.
	Personal injury	The angle and height of the display installation should be appropriate, and the sharp corners should be packaged to prevent damage to the human body from the tough outer casing.
	Special environment	Display screen for special environment (1, seaside, swimming pool, bathing room, basement, tunnel; 2, chemical environment, vulcanization environment, halogen environment; 3, dust, dusty environment; 4, strong ultraviolet environment; 5, the environment of strong electromagnetic fields; 6, less than -20 degrees, higher than +40 degrees of the environment), The review process is required before placing the order.
Operational precautions	Electro-static Protection	The worker must wear an anti-electrostatic wrist strap and anti-electrostatic glove. Various tools must be strictly grounded during assembly
	Product batch control	Different batches of products cannot be installed in the same screen, otherwise there will be color blocks (mosaic) on the display.
	Product wiring	The module cannot be directly connected to 220V, and the module positive and negative poles connection must be right.
	Disassembly and transportation	Do not throw, push, squeeze or press the module to avoid damaging the display screen.
	Disassembly and maintenance liquid protection	Sweat or other liquid cannot be dripped on the display screen during disassembly and assembly operation. If it is dripped, then use alcohol to clean the product, to prevent the liquid from corroding the product.
	Installation Torque Control	In connection with power supply, it is necessary to ensure tightening of terminal joint screw to prevent joint position from loosening, resulting in wire burning or product damage caused by high contact resistance. Torque of M4 screw is 6.0-8.0 Kgf.cm, and that of M3 screw is 4.0-6.0 Kgf.cm.
	Prohibited work with electricity	It is forbidden to assemble the LED module when the power is on. The LED module should be assembled with the main power input disconnected. It is not allowed to insert the power wire and signal cable when there are with electricity.



Operational precautions	Prohibited touch with electricity	It is forbidden for people to touch the LED display screen when the LED screen is in usage, so as to avoid electrostatic breakdown of LED lights and chips and other components caused by human body friction.	
	Environmental inspection	Temperature and humidity meters should be equipped on the installation site to monitor the surrounding environment of the screen in time. After heavy rain, it is necessary to check whether there are any problems such as dampness, water droplets and over humidity in the screen in time.	
	Requirements for moisture proof	Fixed Installation Display Screen	Within 10% ~ 65% RH relative humidity range, it is recommended to turn on the display 1 time per day, and work at least 4 hours to remove moisture on the display.
			When the relative humidity of the environment is over 65% RH, dehumidification treatment should be carried out for the operating environment. It is suggested to use the screen for more than 8H per day in this environment, and doors and windows should be closed at night to prevent the display from dampness.
			When the display screen is not used for a long time, it is necessary to preheat and dehumidify the whole screen for 8H before using, so as to avoid damaging the lamp tube after dampness. The dehumidification methods are: full brightness set 10%- 1H, full brightness set 30% 2H, full brightness set 60% -2H, full brightness set 80% -2H, full brightness set 100% -1H (brightness gradually increasing aging).
			After usage , immediately put into flight case and seal the flight case; In each flight case, please put a desiccant or hygroscopic bag of not less than 50g.
Rental screen display:		In the range of 10% to 65% RH relative humidity, the screen should be lighted on more than 2H every half month; More than 65% RH and in the resurgence weather, the screen must be lighted on more than 2H every week. After finished the display, need to put it back to flight case, sealed and stored. (please check whether there is any failure of the desiccant or hygroscopic bag in the aviation, it needs to be replaced every 2 months, and more desiccant can increase the dryness inside the box.)	



Operational precautions	Requirements for moisture proof	<p>When the display screen is not in use for a long time, it is necessary to reduce the brightness of the whole screen by 50% in advance and play it for 12 hours, and preheat it for "dehumidification" 12H to avoid damaging the light tube after the LED screen is damped.</p> <p>While renting, do not touch the display screen with water. If there is any water, make sure that the water on the screen is dried. After 2H, light the display screen 2H, and evaporate the water by lamp and IC heat.</p> <p>It is strictly forbidden to use indoor rental screens as outdoor rental screens, especially in the open air environment.</p>
	Avoid construction work to the installed LED screen	It is strictly forbidden to rebuild after the installation of the LED display screen, so as to prevent the LED display screen from being affected by the impact of high current and dust, such as welding, electric saw and other equipment.

3. Product manual

3.1.The indoor full-color display has a clearer and more delicate effect, and the resolution can reach above 1080P; achieves high refresh rate, high grayscale and higher lamp utilization; no residual image, anti-'caterpillar', low power consumption, low glitch and other functions;

3.2.The indoor full-color display is mainly composed of red LED chips, green LED chips and blue LED chips packaged into a matrix of pixels, and then fixed to a plastic package;

3.3.The indoor full-color display contains a driver chip and an input buffer chip, which can display video, image and text information when connected to the LED display control system;

3.4.Through the system control to drive the red LED, green LED and blue LED driver chip, 4,398 billion color conversions can be formed;

3.5.The unit board and the box can be spliced arbitrarily in the horizontal and vertical directions to form different sizes of displays;

3.6.Features:

- High-quality lamp tube, high-efficiency lamp brightness utilization rate, while guaranteeing



lamp tube service life and high-quality plastic parts

- High contrast can achieve good display effect
- The weight is easy to install and remove
- Single point and single lamp maintenance can be carried out, with low cost
- Drive LED with constant current, uniform light emission and low power consumption

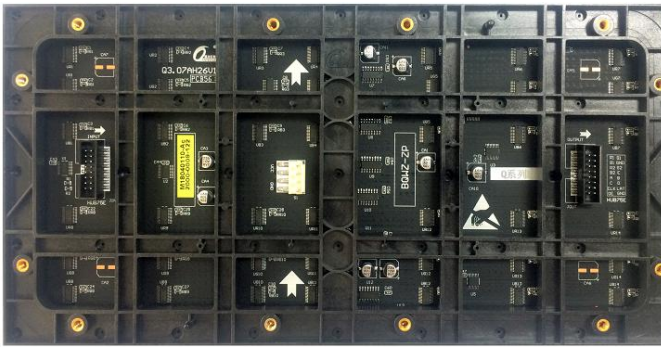
3.7.Module Picture

Front View		<p>Remarks: The driver chip uses a QFP packaged constant current driver chip;</p>
Rear View		

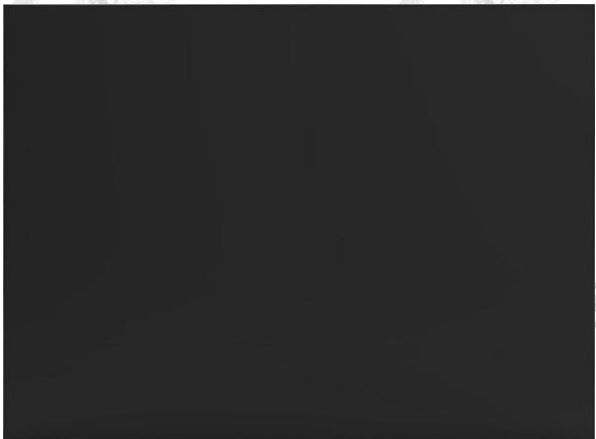
3.8.Suggestion Cabinet -(640*480 MGLED)

Front View	Rear View
	
Side view 1	Side view 2



Front Service

Rear Service

4. Technical Specification

4.1. Screen

Brightness	≥600cd/m ²	Brightness Uniformity	>0.95
Horizontal Viewing Angle	140±10degree	Vertical Viewing Angle	130±10degree
Best Viewing Distance	≥3m		
Max power per square unit module	≤413W/m ²	Operation Environment	Indoor
Distribution power (maximum power per square ÷ 78% ÷ 85%)			≤623W/m ²
Grayscale	14-16bits (RGB each)	Display Color	4398 Billion
Frame Frequency	≥60 frame/sec	Refresh Frequency	3840Hz
Control Mode	Computer control, Point-to-point Video synchronization	Brightness Adjustment	256-grade manual / automatic



厦门强力巨彩光电科技有限公司
Xiamen Qiangli Jucai Opto-Electronic Technology Co.,Ltd.

规格型号:	Q3.0-26S-Pro-2020
文件编号:	
版本编号:	2.7

	Real-time display		
Input Signal	DVI/VGA , Video (multiple formats)RGBHV、 Composite video signal、 S-VIDEO YpbPr(HDTV)		
Life Span	≥100,000 hours	Average Failure Free Time	≥10,000 hours
Attenuation (3 years later)	≤15%	Continuous out of control point	0
Discrete Out of Control Point	< 0.0001, 0 when leaving the factory	Blind spot rate	< 0.0003, 0 when leaving the factory
Operating temperature range	-20-40℃	Operating Humidity	10 % -65 % RH(No condensation)
Protection performance	Over temperature/overload/power down/image compensation/various correction technologies/overcurrent/overvoltage/lightning protection (optional)		
Horizontal flatness of the screen	< 1mm/m ²		
Vertical flatness of the screen	< 1mm/m ²		

4.2.Cabinet (MGLED)

Cabinet Size (Width*Height*Thickness)	640*480*84mm (with module, cabinet, connecting plate)
Cabinet Pixel Density	208*156=32448Dots
Cabinet Area	0. 307 m ²
Cabinet Weight	7. 55kg±0. 05 kg
Cabinet Max Power Consumption(unit board power * number of unit boards in a cabinet)	≤127W
Average Power Consumption (1/3 Max)	≤42W
Distribution power (78% power utilization rate, i.e. max power ÷ 78%)	≤163W

4.3.Module

Pixel Pitch	3. 0mm	Pixel Density	105625Dots/m ²
Configuration	1R1G1B	LED Lamp	SMD2020
Size (Width*Height*Thickness)	320*160*14mm	Weight	0. 32kg±0. 01kg
Structure	Lamp & IC in same PCB	Resolution	104*52=5408Dots
Input Voltage (DC)	4. 5±0. 1V	Maximum Current	≤4. 7A
Power Consumption	≤22W	Driving Method	Constant Current 1/26 Scan
40A Power Supply for	5-6pcs module	50A Power Supply for	7-8pcs module
40A PFC Power Supply for	7-8pcs module	80A Power Supply fo	12-13pcs module

5.Signal Pin

HUB75E

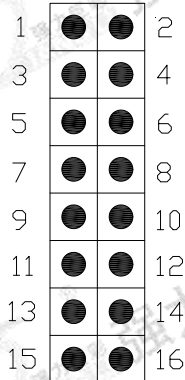

引脚	信号	功能	引脚	信号	功能
1	RD1	Red data signal	2	GD1	Green data signal
3	BD1	Blue data signal	4	GND	GND
5	RD2	Red data signal	6	GD2	Green data signal
7	BD2	Blue data signal	8	E	Line power control signal
9	A	Line power control signal	10	B	Line power control signal
11	C	Line power control signal	12	D	Line power control signal
13	CLK	Clock signal	14	LAT	Data locking signal
15	OE	Enable signal	16	GND	GND

6. Product model naming instructions

X XXX X X X X

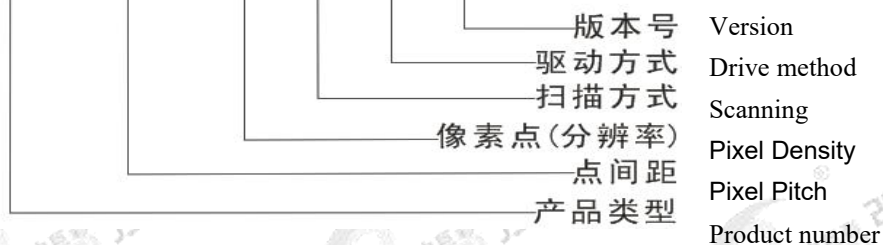

7. Mounting hole diagram



7.1. Mounting holes of the unit module

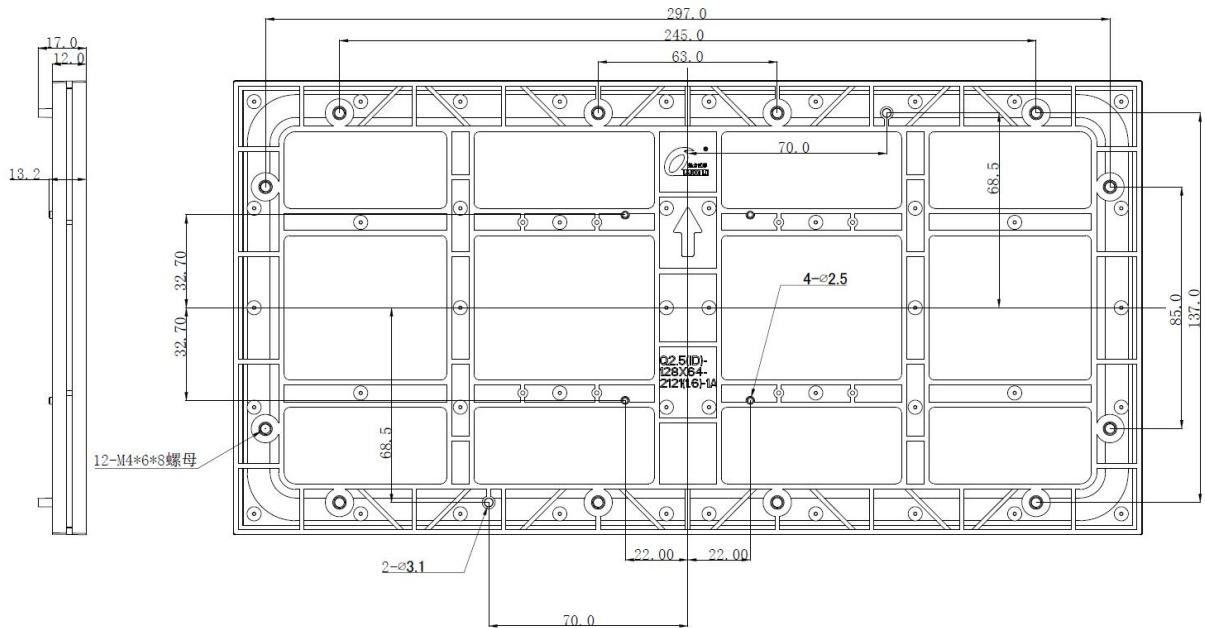

Remarks: "If you have to make a cabinet, please inform the office in advance and confirm the hole position map of the ordered product. Please refer to the CAD drawing for details." All dimensions are in mm.

7.2. Recommended 640*480 cabinet installation hole diagram

40*40Square tube

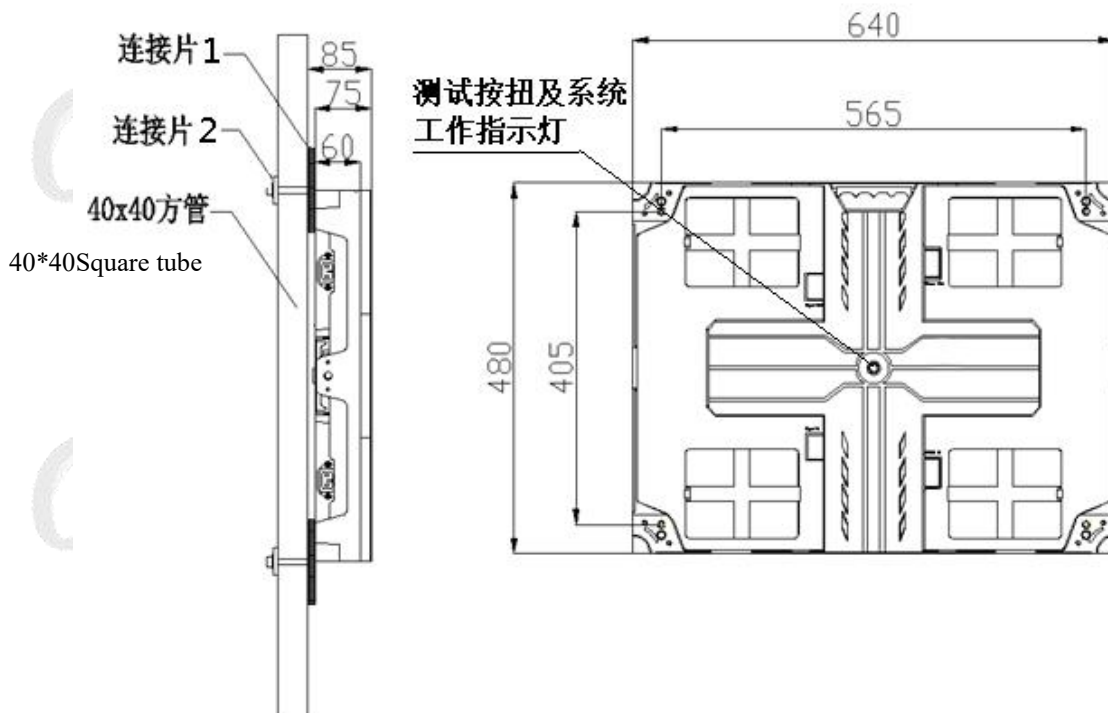

Remarks: All dimensions are in mm
This unit board and box body adopts magnetic attraction and front maintenance technology, which is convenient for disassembly and assembly

8. Installation Instructions

8.1. Schematic diagram of the connection between the power supply and the unit module (this diagram is for reference only, and the specific connection method refers to the actual product):

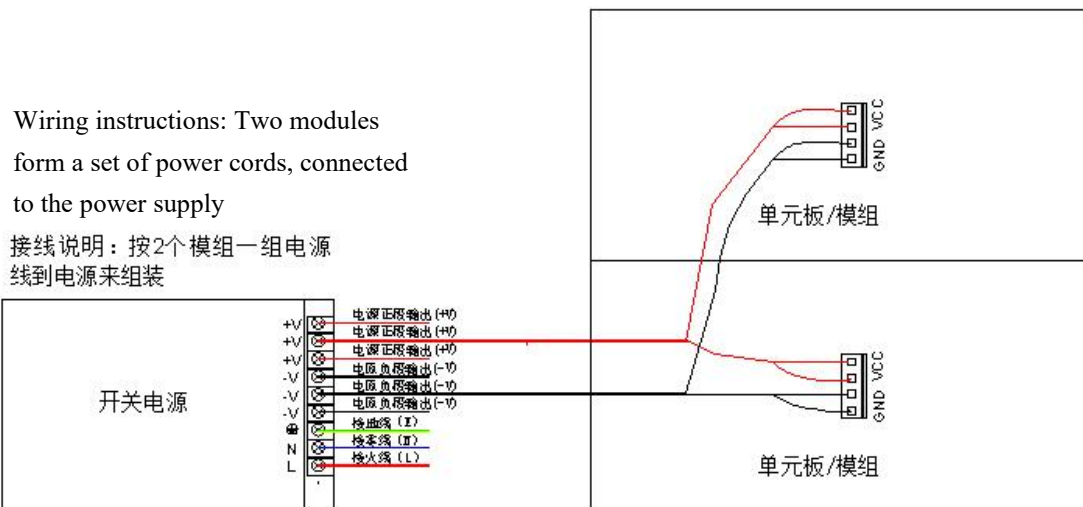

8.2. Installation introduction:

8.2.1. Display installation method: It can be used as an indoor rental, and it supports fixed installation, hoisting and wall-mounted installation methods to meet the needs of various indoor installation environments.



8.3. Screen acceptance requirements and methods:

8.3.1. Screen brightness: adjust the screen to full brightness, adjust the brightness in

the test software to 80% on the computer, and use a light gun to measure the brightness of the screen within 10 minutes. To measure brightness, the light gun must be aligned with the screen. It is best to measure the light gun to be level with the screen. Make sure that the black position of the observation window covers more than 16 pixels. Adjust the focus to measure.

8.3.2. Viewing angle: When measuring, people stand at a position of 140° to the left and right of the screen, and the viewing angle under the screen is 65° .

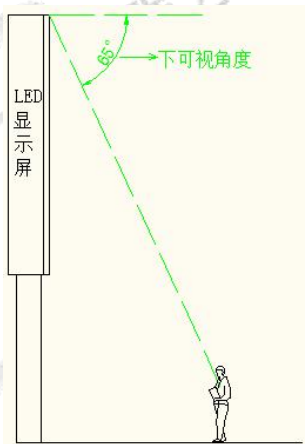

Top and bottom viewing angles

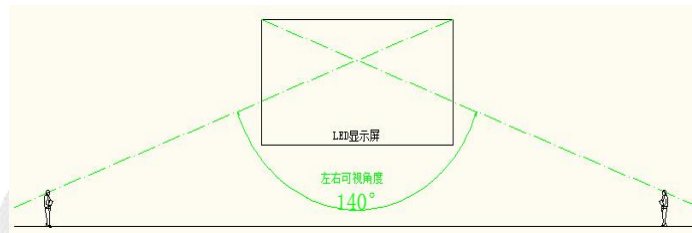

Left and right viewing angle of screen

8.3.3. Grounding: The shell, box, and screen structure of the switching power supply are properly grounded, and the grounding point is properly grounded, and spot inspection is performed every six months.

8.3.4. Lightning protection treatment: The building is required to have lightning rods or lightning protection belt facilities and effective grounding, and the distribution box is required to be equipped with surge protectors. The lightning protection facilities shall be inspected every six months.